



Alles geregelt



Multi-colour backlight



Ease of operation



High compatibility



Customised settings



Safety



Open window sensor

ECOTIMER P

Universal controller HRT 6510-50

1. Description of function

The HRT 6510 is a universal controller with integrated **Powerline Module**. To integrate it into your home network, use the **existing power line**. No WLAN connection is required. To connect the controller to your home network, use a powerline adapter. Range problems, losses in transmission, and environmental load arising from radio waves are thus a matter of the past. In addition to the conventional operation of the controller while at home, access to the temperature controller is also possible via a web-based user interface – at any time and from any location.

The HRT 6510 is a universal temperature control unit with multi-colour RGB LED-backlit display. Any colour can be selected in accordance with the customer's individual wishes.

The temperature controller is equipped with a current-saving power supply unit which not only contributes to the saving of natural resources with 15% less energy consumption compared to conventional control units, but thanks to lower energy consumption also helps to reduce your energy costs.

The device can be used as a

Room temperature controller in the range between 5° and 30 °C, as a

Floor temperature controller in the range between 10° and 40 °C, and as a

Room temperature controller with monitoring function:

Room temperature: 5° ... 30 °C

Floor temperature monitoring: 20° ... 40 °C

Room temperature controller with window sensor: 5 ... 30 °C

Supplementary heating: Max. 120 min. in the range between 10 and 40 °C

Cooling controller: 5 ... 30 °C

The configurations above can be made in the main menu under "Setup". By default, the control unit is configured as a floor temperature controller.

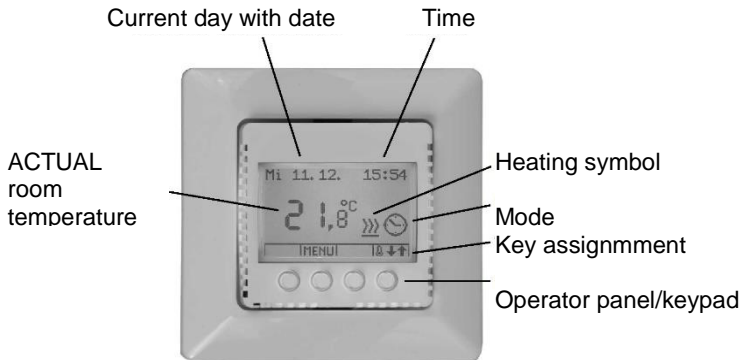

Turning on the controller for the first time:

After turning on, the controller takes approx. 30 sec. to power up; do not interrupt the power-up cycle. Then the standard display appears.

2. Operation

The menu navigation is assisted by appropriate textual information in a user-friendly manner.

Keys:

+ / -	Plus / Minus	Change value
← / → / ↑ / ↓	Arrow keys	Select direction
↶	Back arrow	Quit menu
MENU	Menu	Confirm
SET	SET key	Enable setting changes
CLR	Clear key	Clear value
OK	OK	Confirm value
🔒↕↕	Change target temperature	Change desired temperature

Use the plus and minus keys to change the value; use the back arrow to quit the menu.

If no inputs are made for 10s, the display is reset to the default values.

To turn on the backlight, press any key once.

Key lock: 🔒

Enable key lock

Simultaneously press and hold down the keys 1 and 4 for 10s until the lock symbol is displayed.

Disable key lock

Simultaneously press and hold down the keys 1 and 4 for 10s; key lock is disabled.

Change target temperature: 🔒↕↕

The desired temperature can be set at any time in the standard display by way of the key "Change target temperature".

Select mode: MENU

To turn on the backlight, press any key once.

To activate the "Mode" menu, press the MENU key. Use the arrow keys for mode selection.



FROST PROTECTION



MANUAL



AUTOMATIC

OK

Press OK to confirm

Main menu: MENU

Press and hold down the MENU key for **3 sec.**; use the arrow keys for selection.



Comfort temp. (is used to program the comfort temperature times)



Temperatures (frost protection/setback temperature)



Display (brightness, backlight, contrast, colour settings)



Settings (date, time, daylight time, language, unit)



Setup (controller and sensor probe mode, offset, teach-in function, program, setback temperature 2, switching output)



Device info (software version, operating hours, error messages, factory settings)



Network (DHCP, IP address, hostname, time server, time zone, user name, password)



HomePlug (Add HomePlug, default setting)



Grouping (New Group, Add Group)

Comfort temperature times:



Programming of the comfort temperature times in block or single day mode

Block mode: Same time program for the workdays 1 to 5 (1 = Monday, 2 = Tuesday, etc.)
Weekend (6 = Saturday, 7 = Sunday)
single day mode programming: Daily changeable time program
(is selected in the *SETUP* menu)

Default settings:

Mon - Fri	Time 1	06:00 a.m. -> 09:00 a.m.
Mon - Fri	Time 2	05:00 p.m. -> 10:00 p.m.
Sat - Son	Time 1	06:00 a.m. -> 09:00 a.m.
Sat - Son	Time 2	05:00 p.m. -> 10:00 p.m.

Outside the comfort temperature times, the setpoint temperature is reduced to the setback temperature.

Temperatures:



Display or change frost protection ranges/setback temperatures

Frost protection	Range: 3.0 ... 15.0 K	Default setting: 5.0 K
Setback temperature 1	Range: 1.0 ... 15.0 K	Default setting: 3.0 K
Setback temperature 2	Range: 1.0 ... 15.0 K	Default setting: Nothing is displayed (is selected in the <i>SETUP</i> menu)
Sensor temperature	Range: 20.0 ... 40.0 K (variant with temperature monitoring only)	Default setting: 28.0 K

Display:



Display and change brightness, backlight, contrast, and colour settings

Brightness	Range: 0 ... 100%	Default setting: 75%
Backlight time	Range: 10 ... 60 s	Default setting: 30 s
Contrast	Range: 0 ... 100%	Default setting: 50%
Red	Range: 0 ... 100%	Default setting: 25%
Green	Range: 0 ... 100%	Default setting: 55%
Blue	Range: 0 ... 100%	Default setting: 40%

Colour legend:

(RGB colour = Red/green/blue) Specified in percent

Colour	Red	Green	Blue	Colour	Red	Green	Blue
Red	100	0	0	Orange	100	65	0
Green	0	100	0	Yellow	100	100	0
Blue	0	0	100	Green	0	50	0
Fuchsia	100	0	100	Olive	50	50	0
Purple	100	73	100	Maroon	50	0	0
White	100	100	100	Navy	0	0	50

Display-settings:



Automatic timing	ON / OFF	Default setting: ON
Daylight time	OFF → Set date/time manually OFF / ON	Default setting: ON
Language	OFF → Set time manually German, English, and others	Default setting: German
Unit	Celsius / Fahrenheit	Default setting: Celsius
Floor temperature	OFF / ON ON → The floor temperature is displayed. (and, in addition, the floor temperature symbol) OFF → The room temperature is displayed.	Default setting: OFF





SETUP:



Display and change controller mode, sensor probe mode, offset settings, teach-in function, program, setback temperature 2, switching output, cooling controller, valve protection, switching cycle, supplementary heating, switching power

Any changes in the SETUP menu can lead to uncontrolled functions and should therefore only be performed by authorised electrical experts.

Controller mode	Select Room temperature controller Floor temperature controller	Default setting: Floor temperature controller
	Room temperature controller + sensor Room temperature controller + open window sensor (integrated shutdown; all the other controllers via external pluggable connector)	
	After changing the controller mode, it is imperative for safety reasons to set it to "Frost protection" (check that the frost protection symbol is displayed); check the comfort and setback temperatures.	
Sensor type selection	HRT sensor 10 kΩ NTC, e.g. Busch-Jaeger 12 kΩ NTC, e.g. OJ 15 kΩ NTC, e.g. DEVI 33 kΩ NTC, e.g. Eberle 2 kΩ PTC	Default setting: Sensor
Room temperature offset	Measurement correction for the room temperature display Range: - 3.0 K ... 3.0 K	Default setting: 0.00 °C
Floor temperature offset	Measurement correction for the floor temperature display Range: - 3.0 K ... 3.0 K (floor and room temperature controllers with temperature monitoring only)	Default setting: 0.00 °C
Teach-in function	Autonomous determination of the preheating time to be able to reach the selected comfort temperature OFF / ON	Default setting: OFF
Program	Select block program or single day mode program	Default setting: Block program
Setback temperature 2	Allows you to select a different setback temperature between the end of the comfort time 1 and the beginning of the comfort time 2 OFF / ON	Default setting: OFF

Switching output	Inverting this setting allows you to operate the actuator in "normally open" mode OFF / ON Default setting: OFF
Cooling controller	If you connect the controller to an air-conditioning system, it is possible to cool down to the desired room temperature. OFF / ON Default setting: OFF
Valve protection	Activate the switching output every day for 1 min. to prevent deposits and seizing of the hydraulic and mechanical actuators. OFF / ON Default setting: OFF
Switching cycle	Change the time between two switching processes to correct the measurement results in case of an unfavourable place of installation. Range: 0 ... 10 min. Default setting: 0 min.
Supplementary heating	Use the timer function for additional heating; the heating automatically switches off after the selected time (max. 120 min.). Floor temperature controller Heating temperature max. 40 °C Room temperature controller / sensor Heating temperature max. 30 °C OFF / ON Default setting: OFF It is imperative for safety reasons to switch the supplementary heating to "Frost protection" after quitting the program. (Check that the frost protection symbol is displayed); check the comfort and setback temperatures.)  Timer control active  Start timer  Timer stop  Change time of timer
Switching power	Specify the load (kW) of the device to be controlled for statistic determination of the energy consumption. Power in kW Default setting: 0 kW

About:



Displays floor temperature, software version, MAC address, number of total operating hours, error messages, factory default settings, and the energy consumption.

Floor temperature display (floor and room temperature controllers with temperature monitoring only)

- Software version
- MAC address
- Operating hours
- Error messages
- Factory settings No / Yes Default setting: No
- Consumption

Network:



Specify the network settings

- DHCP OFF / ON Factory setting OFF
- IP address Specify the IP address of your router
- Hostname Specify the hostname of your computer
- Time server e.g. "time.fu-berlin.de"
- Time zone +1 h
- User name Specify a user name. Default setting: admin
- Password Specify a password. Default setting: admin
- Smart home: Web-based user interface for direct access to your controller; enter your IP address in the browser

HomePlug:



Is used to set up the HomePlug connection

- Add to network No / Yes Default setting: No
- ON: → A connection to your network/to the internet is established via the HomePlug adapter automatically.
- If the HomePlug modules are installed in different phases, a phase coupler should be installed in the electrical distribution.
- Default setting: No / Yes Default setting: No

Grouping:



Use the grouping function to summarise several controllers with the same function in a group.

- New group Specify group name (master)
- Add controller Add a controller to an existing group (slave)

Up to 3 different types of groups can be specified.

- Temperature (The slave is controlled to the temperature settings of the master.)
- Time (The slave is controlled to the time settings of the master.)
- Temperature & time (The slave is controlled to the temperature and time settings of the master.)
- Default setting: OFF

3. Symbols

Mode symbols

- Setback mode
- Setback temperature 1
- Heating
- Heating teach-in function

- Timer control
- Setback temperature 2
- Cooling
- Cooling teach-in function

Status symbols

- Floor monitoring switches off
- Open window sensor
- Key lock
- Network connection
- Network data transfer
- Group control

- Error
- Floor temperature display
- Valve protection active
- No network connection
- No HomePlug

4. Connection / Commissioning

ATTENTION: Work on the 230V mains must only be performed by authorised electrical experts. When connecting the device, observe the safety regulations of the local power supply companies. Control arrangements for water heating systems require setting values of the "normally closed" type.

Installation:

The temperature controller is to be installed in a standard flush box Ø 55mm (acc. to DIN 49073, Part 1). When using supplementary intermediate terminals, we recommend to use a deep switch box. It is connected as to be seen on the wiring diagram (see illustration). Make sure that the connection cables are straight; their ends must be stripped by approx. 5mm. Installation height: Approx. 1.5m above the floor.

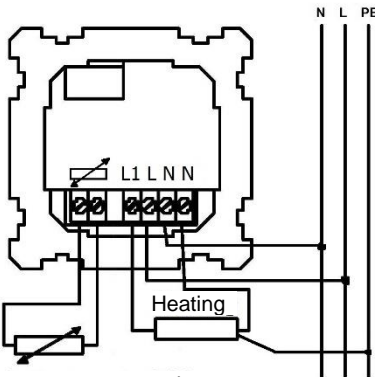

Floor temperature probe

must be routed in a separate protective conduit (not

Attention: Place the frame ring over the edges of the wallpaper. Mount the controller on the mounting box by using thread-forming tapping screws supplied with the box. Then place the frame onto the insert of the flush box.

Attention: Before fitting the cover of the box, check that the internal sensor (left bottom) points downwards at an angle. Make sure that the sensor is not in contact with the housing of the controller.

The floor temperature sensor probe cable is to be routed in a protective conduit on the level of the heating mats centrally between the heating mats. The sensor probe cable

together with cables carrying mains power).

Attention: In case of error, the sensor probe cable could carry a hazardous mains voltage!

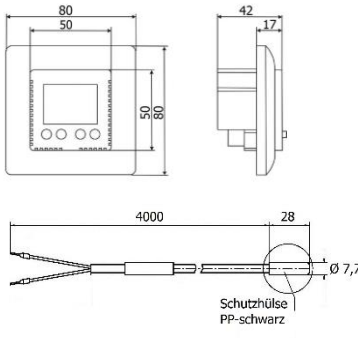

Sensor probe characteristic:

Temp. °C	Resistance kΩ
10	3,66
20	2,43
30	1,66
40	1,15
50	0,82

Protective conduit
PP, black

5. Technical Specifications

Designation:	HRT 6510-50
Setting ranges:	
Room temperature controller:	5 ... 30 °C
Floor temperature controller:	10 ... 40 °C
Floor temperature monitoring:	20 ... 40 °C
Supplementary heating:	10 ... 40 °C
Cooling controller:	5 ... 30 °C
Specification:	Multi-colour display
Powerline:	HomePlug module
Mains voltage:	230 V ~ ±10%, 50 Hz
Switching current (max.), approx.:	12 (4) A
Switching power:	2.7 kW
Power consumption in standby mode:	1.0 W
Maximum number of group controller:	16 per group
Switching temperature difference:	0.7 K
Temperature sensor:	NTC acc. to DIN 44574, 4m long
Permissible ambient temperature:	-10 ... +40 °C
Connection cables:	2.5 mm ²
Degree of protection:	IP30
Energy class	VII
Contribution to energy efficiency:	3.5%
Housing dimensions:	71 x 71 x 41 mm
Frame dimensions:	80 x 80 mm
Colour:	Alpine-white (similar to RAL 9010)
Compatibility:	50x50 mm, with intermediate frame
Weight:	84 g
Weight of the floor sensor:	140 g

Default settings:

Default display temperature:	Room temperature
Default controller:	Floor temperature controller
Default sensor type:	HRT standard floor sensor
Default room temperature offset:	0.0 K
Default floor temperature offset:	0.0 K
Teach-in function:	Off
Type of programming:	Block programming
Comfort times	Mon - Fri 6:00 a.m. - 9:00 a.m. / 05:00 p.m. - 10:00 p.m. Sat - Son 6:00 a.m. - 9:00 a.m. / 05:00 p.m. - 10:00 p.m.
First temperature reduction:	3 °C
Second temperature reduction:	Off
Switching output inverted:	Off
Cooling controller:	Off
Valve protection:	Off
Switching cycle:	0 min.
Supplementary heating:	Off
Switching power:	0 kW
Frost protection:	5 °C
Automatic timing	On
Automatic daylight time:	On
Network:	Off
HomePlug:	Off
Grouping:	Off

6. Troubleshooting

Diagnosis	Possible Cause / Remedy
Heating does not work	Connect / check mains voltage
Display:	
- No display	Mains power failure
- Error	System-relevant error (e.g. sensor breakage)
- HomePlug	Network not connected/does not exist
- Probe error	Probe not connected/defective - check
- Window sensor	Window sensor not connected/defective
- Switches too early / too late	Check settings in the program
- No reaction when changing temp.	Check setback mode
- Network error	See display for detailed error messages
- System reset	Simultaneously press keys 1, 2 and 4 for 10s.; all user data are retained

Notes

Our service for you at a glance:

Article no.: HRT 6510-50

Purchased on: _____

Installed on: _____

MAC address: _____

Your service technician: _____

7. Warranty

We assume a warranty for the controller within the framework of the relevant statutory regulations.

Exclusion: Natural wear or transport damage, as well as damage due to failure to observe the installation instructions, improper or unqualified installation and use other than as intended are not covered by the liability for defects. We do not assume liability arising from the consequences of improperly performed modifications or repair. This also applies to the delivery of components and spare parts. HRT does not assume liability for damage on the delivery item itself, in particular not for indirect consequential damages or financial losses.

Disposal:  Disposal of electronic devices in Germany: Do not dispose of devices bearing the symbol shown in the illustration (crossed-out wheeled bin) in the residual waste. The Waste Electrical and Electronic Equipment Directive (WEEE) provides for free return to your local collection point. Disposal of electronic devices outside Germany: Dispose of in accordance with legal regulations of your country.

	<p>HRT Hausregeltechnik GmbH</p> <p>Enzmannstraße 4 D-09112 Chemnitz</p>	<p>Tél. +49 (0) 371 / 81 00 1975 Fax +49 (0) 371 / 81 00 1976 info@hausregeltechnik.com www.hausregeltechnik.com</p>
---	---	--